



# VWR MICRO STAR 17 / 17R

## INSTRUCTION MANUAL

European Catalog Numbers:

VWR MICRO STAR 17: 521-1646

VWR MICRO STAR 17R: 521-1647

Version: 1

Release: 01, 02, 2012



Delrin, TEFLON, and Viton are registered trademarks of DuPont. Noryl is a registered trademark of SABIC POLYCLEAR is a registered trademark of Hongye CO., Ltd. Hypaque is a registered trademark of Amersham Health As. RULON A and Tygon are registered trademarks of Saint-Gobain Performance Plastics. Alconox is a registered trademark of Alconox. Ficoll is a registered trademark of GE Healthcare. Haemo-Sol is a registered trademark of Haemo-Sol. Triton X-100 is a registered trademark of Sigma-Aldrich Co. LLC.

VWR International bvba  
Researchpark Haasrode 2020  
Geldenaaksebaan 464  
B-3001 Leuven  
+ 32 16 385011  
<http://be.vwr.com>

**VWR makes no representations that this document is complete, accurate or error-free and assumes no responsibility and will not be liable for any errors, omissions, damage or loss that might result from any use of this document, even if the information in the document is followed properly.**



# EC Declaration of Conformity

## Déclaration de conformité CE

### EG Konformitätserklärung

We, **VWR International bvba**,  
Nous, **Researchpark Haasrode 2020**,  
Wir, **Geldenaaksbaan 464**,  
**B-3001 Leuven**

hereby declare that the products, mentioned in Schedule comply with the essential requirements of the following Directives of the European Parliament and council:

*déclarons par la présente que les produits mentionnés en annexe sont conformes aux exigences essentielles des Directives du Parlement Européen et du Conseil suivantes :*

*bestätigen hiermit, daß die Produkte im Anhang den grundlegenden Anforderungen der folgenden Richtlinie des Europäischen Parlaments und des Rates entsprechen:*

<b>2006/95/EC</b>	of 12 December 2006 on the harmonisation of the laws of Member States relating to electrical equipment designed for use within certain voltage limits <i>du 12 décembre 2006 concernant le rapprochement des législations des États membres relatives au matériel électrique destiné à être employé dans certaines limites de tension</i> vom 12. Dezember 2006 zur Angleichung der Rechtsvorschriften der Mitgliedstaaten betreffend elektrische Betriebsmittel zur Verwendung innerhalb bestimmter Spannungsgrenzen
<b>2004/108/EC</b>	of 15 December 2004 on the approximation of the laws of the Member States relating to electromagnetic compatibility and repealing Directive 89/336/EEC Text with EEA relevance <i>du 15 décembre 2004 relative au rapprochement des législations des États membres concernant la compatibilité électromagnétique et abrogeant la directive 89/336/CEE Texte présentant de l'intérêt pour l'EEE</i> vom 15. Dezember 2004 zur Angleichung der Rechtsvorschriften der Mitgliedstaaten über die elektromagnetische Verträglichkeit und zur Aufhebung der Richtlinie 89/336/EWG Text von Bedeutung für den EWR
<b>2006/42/EC</b>	of 17 May 2006 on machinery, and amending Directive 95/16/EC <i>du 17 mai 2006 relative aux machines et modifiant la directive 95/16/CE</i> vom 17. Mai 2006 über Maschinen und zur Änderung der Richtlinie 95/16/EG
<b>2011/65/EC</b>	of 8 June 2011 on the restriction of the use of certain hazardous substances in electrical and electronic equipment <i>du 8 juin 2011 relative à la limitation de l'utilisation de certaines substances dangereuses dans les équipements électriques et électroniques</i> vom 8. Juni 2011 zur Beschränkung der Verwendung bestimmter gefährlicher Stoffe in Elektro- und Elektronikgeräten

and are in conformity with the following standard(s) and/or other normative document(s):

*et sont conformes à la (aux) norme(s) ou autre(s) document(s) normatif(s) :*

und der (die) folgende(n) Norm(en) oder ander(er) normativ(er) Dokument(e) entsprechen:

**EN 61010-1:2004; EN 61010-2-020:2006; EN 61010-2-101:2002**

**EN 61326-1:2006; EN 61326-2-6:2006**

**EN 55011B:2007**

Year of CE marking: **2011**  
*Année d'apposition du marquage CE:*  
*Jahr der CE-Kennzeichnung :*

Place and date of issue: **Leuven, 13/02/2012**  
*Lieu et date d'émission :*  
*Ort und Ausgabe Datum:*

  
Yves Van Damme  
European Regulatory Affairs Manager

  
Frankie Vangeel  
Managing Director

1/2

VWR International bvba/sprl Researchpark Haasrode 2020, Geldenaaksebaan 464, B-3001 Leuven, Belgium

Tel.: 016 385 011 • Fax: 016 385 385 • E-mail: [info@be.vwr.com](mailto:info@be.vwr.com)

Revision 01 of Feb 2012



**EC Declaration of Conformity**  
**Déclaration de conformité CE**  
**EG Konformitätserklärung**

Schedule 1

Annexe 1

Anhang 1

Article Number	Article description
521-1646	<b>MICROCENTRIFUGE VWR MICRO STAR 17 VENTILATED</b> <i>MICROCENTRIFUGEUSE VWR MICRO STAR 17 VENTILEE</i> <i>MIKROZENTRIFUGE VWR MICRO STAR 17 LUFTGEKÜLHT</i>
521-1647	<b>MICROCENTRIFUGE VWR MICRO STAR 17R REFRIGERATED</b> <i>MICROCENTRIFUGEUSE VWR MICRO STAR 17R REFRIGEREE</i> <i>MIKROZENTRIFUGE VWR MICRO STAR 17 GEKÜHLT</i>

# WEEE Conformity

This product is subject to the regulations of the EU Waste Electrical & Electronic Equipment (WEEE) Directive 2002/96. It is marked by the following symbol:



This equipment is marked with the crossed out wheeled bin symbol to indicate that this equipment must not be disposed of with unsorted waste.

Instead it's your responsibility to correctly dispose of your equipment at lifecycle -end by handling it over to an authorized facility for separate collection and recycling. It's also your responsibility to decontaminate the equipment in case of biological, chemical and/or radiological contamination, so as to protect from health hazards the persons involved in the disposal and recycling of the equipment. For more information about where you can drop off your waste of equipment, please contact your local dealer from whom you originally purchased this equipment.

By doing so, you will help to conserve natural and environmental resources and you will ensure that your equipment is recycled in a manner that protects human health.

Thank you

# Table of Contents

	<b>Preface</b> .....	<b>iii</b>
	<b>Scope of supply</b> .....	<b>iii</b>
	<b>Intended use</b> .....	<b>iv</b>
	<b>Accident prevention</b> .....	<b>iv</b>
	<b>Precautions</b> .....	<b>v</b>
<b>Chapter 1</b>	<b>Introduction and description</b> .....	<b>1-1</b>
	Characteristics of the VWR MICRO STAR 17 / 17R .....	1-2
	Technical data .....	1-2
	Mains supply .....	1-3
	Functions and features .....	1-3
<b>Chapter 2</b>	<b>Before use</b> .....	<b>2-1</b>
	Before setting up .....	2-2
	Transporting the centrifuge .....	2-2
	Location .....	2-2
	Aligning the centrifuge .....	2-3
	Mains Connection .....	2-3
	Storage .....	2-4
<b>Chapter 3</b>	<b>Control panel and keys</b> .....	<b>3-1</b>
	Control panel .....	3-2
	Keys .....	3-3
<b>Chapter 4</b>	<b>Introduction and description</b> .....	<b>4-1</b>
	Switch on centrifuge .....	4-2
	Door opening .....	4-2
	Close door .....	4-2
	Rotor installation .....	4-2
	Entering parameters .....	4-4
	Centrifugation .....	4-7
	Short-term centrifugation .....	4-8
	Removing the rotor .....	4-8
	Aerosol-tight rotors .....	4-9
	Audible alarm .....	4-9
	Turning off the centrifuge .....	4-9
<b>Chapter 5</b>	<b>Before use</b> .....	<b>5-1</b>
	Rotor data .....	5-2
	Rotor accessory .....	5-2

## Table of Contents

	Rotor life-time .....	5-2
	Rotor Installation .....	5-3
	Aerosol-tight applications .....	5-5
	Basic principles .....	5-5
	Fill level .....	5-6
	Checking the aerosol-tightness .....	5-6
<b>Chapter 6</b>	<b>Maintenance and care .....</b>	<b>6-1</b>
	Cleaning intervals .....	6-2
	Cleaning .....	6-2
	Disinfection .....	6-4
	Decontamination .....	6-5
	Autoclaving .....	6-5
	Service of VWR .....	6-6
	Shipping and deposing of accessories .....	6-6
<b>Chapter 7</b>	<b>Troubleshooting .....</b>	<b>7-1</b>
	Mechanical emergency lid release .....	7-2
	Troubleshooting by user .....	7-3
	When to contact customer service .....	7-6
	<b>Chemical Compatibility Chart .....</b>	<b>A-1</b>
	<b>Autoclaving Protocol .....</b>	<b>B-1</b>

## Preface

Before starting to use the centrifuge, read through this instruction manual carefully and follow the instructions.

The information contained in this instruction manual is the property of VWR; it is forbidden to copy or pass on this information without explicit approval.

Failure to follow the instructions and safety information in this instruction manual will result in the expiration of the sellers warranty.

## Scope of Supply

	Quantity	Check
Centrifuge VWR MICRO STAR 17 / 17R	1	<input type="checkbox"/>
Power supply cable	1	<input type="checkbox"/>
Rotor	1	<input type="checkbox"/>
Square box wrench	1	<input type="checkbox"/>
CD with manual	1	<input type="checkbox"/>

If any parts are missing, please contact your nearest VWR representative.



This symbol refers to general hazards.

CAUTION means that material damage could occur.

WARNING means that injuries or material damage or contamination could occur.



This symbol refers to biological hazards.

Observe the information contained in the instruction manual to keep yourself and your environment safe.



This symbol refers to general hazards.

CAUTION means that material damage could occur.

WARNING means that injuries or material damage or contamination could occur.



## Intended Use

- This centrifuge is a laboratory product designed to separate components by generation of a relative centrifugal force. It separates human samples (e.g. blood, urine and other body fluids) collected in appropriate containers, either alone or after addition of reagents or other additives.
- As general-purpose centrifuge, it is designed to also run other containers filled with chemicals, environmental samples and other non-human body samples.
- The centrifuge is to be used for separating materials of different density or particle size suspended in a liquid.

Maximum sample density at maximum speed:  $1.2 \frac{g}{cm^3}$

## Accident Prevention



**WARNING** If a hazardous situation occurs, turn off the power supply to the centrifuge and leave the area immediately.



**WARNING** Plug the centrifuge only into sockets which have been properly grounded.



Prerequisite for the safe operation of the VWR MICRO STAR 17 / 17R is a work environment in compliance with standards, directives and trade association safety regulations and proper instruction of the user.

The safety regulations contain the following basic recommendations:

- Maintain a radius of at least 30cm around the centrifuge.
- Implementation of special measures which ensure that no one can approach the centrifuge for longer than absolutely necessary while it is running.
- The mains plug must be freely accessible at all times. Pull out the power supply plug or disconnect the power supply in an emergency.

# Precautions

In order to ensure safe operation of the VWR MICRO STAR 17 / 17R , the following general safety regulations must be followed:



- The centrifuge should be operated by trained specialists only.
- The centrifuge is to be used for its intended use only.
- While handling centrifuge, rotor, and samples you must wear laboratory clothing (e.g. gloves).
- Do not move the centrifuge while it is running.
- Do not lean on the centrifuge.
- Use only rotors and accessories for this centrifuge which have been approved by VWR. Exceptions to this rule are commercially available glass or plastic centrifuge tubes, provided they have been approved for the speed or the RCF value of the rotor.
- Do not use rotors which show any signs of corrosion and/or cracks.
- Do not touch the mechanical components of the rotor and do not make any changes to the mechanical components.
- Use only with rotors which have been properly installed. Follow the instructions in section “Rotor installation” on page 4-2.
- Use only with rotors which have been loaded properly. Follow the instructions given in the rotor manual.
- Never overload the rotor. Follow the instructions given in the rotor manual.
- Never open the lid until the rotor has come to a complete stop and this has been confirmed in the display.



- The lid emergency release may be used in emergencies only to recover the samples from the centrifuge, e.g. during a power failure (see section “Mechanical emergency door release” on page 7-2).
- Never use the centrifuge if parts of its cover panels are damaged or missing.
- Do not touch the electronic components of the centrifuge or alter any electronic or mechanical components.
- Please observe the safety instructions.

Please pay particular attention to the following aspects:



- Location: well-ventilated environment, set-up on a level and rigid surface with adequate load-bearing capacity.
- Rotor installation: make sure the rotor is locked properly into place before operating the centrifuge.
- Especially when working with corrosive samples (salt solutions, acids, bases), the accessory parts and vessel have to be cleaned carefully.
- Always balance the samples.

Centrifuging hazardous substances:



- Do not centrifuge explosive or flammable materials or substances which could react violently with one another.
- The centrifuge is neither inert nor protected against explosion. Never use the centrifuge in an explosion-prone environment.
- Do not centrifuge inflammable substances.

**Remaining risk: Improper use can cause damages, contamination, and injuries with fatal consequences.**

- Do not centrifuge toxic or radioactive materials or any pathogenic micro-organisms without suitable safety precautions.

When centrifuging microbiological samples from the Risk Group II (according to the Bio-safety Manual" of the World Health Organization (WHO)), aerosol-tight biological seals have to be used.

For materials in a higher risk group, extra safety measures have to be taken.

- If toxins or pathogenic substances have gotten into the centrifuge or its parts, appropriate disinfection measures have to be taken (see “Disinfection” on [page 6-4](#)).



**Remaining risk: Improper use can cause damages, contamination, and injuries with fatal consequences.**

- Highly corrosive substances which can cause material damage and impair the mechanical stability of the rotor, should only be centrifuged in corresponding protective tubes.

# Introduction and description

## Contents

- “Characteristics of the VWR MICRO STAR 17 / 17R” on page 1-2
- “Technical data” on page 1-2
- “Mains supply” on page 1-3
- “Functions and features” on page 1-3

## Characteristics of the VWR MICRO STAR 17 / 17R

The set speed is reached within seconds. The maintenance-free induction motor ensures quiet and low-vibration operation even at high speeds, and guarantees a very long lifetime.

The user-friendly control panel makes it easy to pre-set the speed, RCF value, run time, and temperature. You can choose between the display of speed and RCF or the entry mode.

These settings can be changed even while the centrifuge is running.

With the help of the  key, you can also centrifuge a sample for just a few seconds, if called for.

The VWR MICRO STAR 17 / 17R is equipped with various safety features:

- The housing is made of impact-resistant plastic and the interior of armor steel.
- The lid is equipped with a view port and a lock.
- The lid of the centrifuge can only be opened while the centrifuge is switched on and the rotor has come to a complete stop. The centrifuge cannot be started until the lid has been closed properly.
- Lid emergency release: For emergencies only, e.g. during power failures (see [“Mechanical emergency lid release”](#) on page 7-2)

## Technical data

The technical data of the VWR MICRO STAR 17 / 17R is listed in the following table.

**Table 1-1.** Technical data VWR MICRO STAR 17

Feature	MICRO STAR 17	MICRO STAR 17R
Environmental conditions	-Use in interior spaces -Altitudes of up to 2,000m above sea level -max. relative humidity 80% up to 31 °C; decreasing linearly up to 50% relative humidity at 40 °C.	-Use in interior spaces -Altitudes of up to 2,000m above sea level -max. relative humidity 80% up to 31 °C; decreasing linearly up to 50% relative humidity at 40 °C.
Permissible ambient temperature during operation	+5 °C to +40 °C	+5 °C to +40 °C
Permissible ambient temperature during storage and transport	-10 °C to +50 °C	-10 °C to +50 °C
Overvoltage category	II	II
Pollution degree	2	2
Heat dissipation	614 BTU/h	1126 BTU/h
IP	20	20
Run time	unlimited	unlimited
Max speed $n_{max}$	13,300 rpm	13,300 rpm
Min speed $n_{min}$	300 rpm	300 rpm
Maximum RCF value at $n_{max}$	17,000 x g	17,000 x g
Maximum kinetic energy	<1.90 kNm	<1.90 kNm

**Table 1-1.** Technical data VWR MICRO STAR 17

Feature	MICRO STAR 17	MICRO STAR 17R
Noise level at maximum speed	< 56dB (A)	< 50 dB (A)
Temperature range		Adjustable from -9 °C to 40 °C, in 1°C increments.
Dimensions		
Height	230 mm	330 mm
Width	240 mm	292 mm
Depth	350 mm	440 mm
Weight with empty rotor	10.5 kg	28.0 kg

## Mains supply

The following table contains an overview of the electrical connection data for the VWR MICRO STAR 17 / 17R. This data is to be taken into consideration when selecting the mains connection socket.

**Table 1-2.** Electrical connection data

Cat.	Mains voltage	Frequency	Rated current	Power consumption	Equipment fuse	Building fuse
521-1646	230 V	50 / 60 Hz	1.4 A	180 W	4A, 2-pole circuit breaker	16 AT
521-1647	230 V	50 / 60 Hz	1.9 A	300 W	4A, 2-pole circuit breaker	16 AT

## Functions and features

The following table gives an overview of the important functional and performance characteristics of the VWR MICRO STAR 17 / 17R.

**Table 1-3.** Functions and Features

Component / function	Description / features
Structure / housing	Sheet metal with attached plastic housing and steel chamber
Rotor chamber	Plastic Up to 48 ml of spilled liquid is retained in the chamber and cannot enter the instrument.
Drive	Induction drive without carbon brushes
Keys and display	Easy-to-clean keypad and display surface
Controls	Microprocessor-controlled
Internal memory	The most recent data is saved
Functions	RCF, temperature, and pretemp selection
Lid lock	Automatic lid closing and locking starting from an initial hold position

## Before use

### Contents

- “Before setting up” on page 2-2
- “Transporting the centrifuge” on page 2-2
- “Location” on page 2-2
- “Aligning the centrifuge” on page 2-3
- “Mains Connection” on page 2-3
- “Storage” on page 2-4

## Before setting up

1. Check the centrifuge and the packaging for any shipping damage.  
Inform the shipping company and VWR immediately if any damage is discovered.
2. Remove the packaging.
3. Remove the rotor transport protection. The cardboard is suppose to prevent damage due to impact.
4. Check the order for completeness (see “[Scope of supply](#)” on [page iii](#)).  
If the order is incomplete, please contact VWR.

## Transporting the centrifuge



**WARNING** Always lift the centrifuge on both sides. Never lift the centrifuge by its front or the back panel.  
Transport the centrifuge if possible in its packaging and with the rotor transport protection.

- Due to its weight (see “[Technical data](#)” on [page 1-2](#)), the centrifuge should be carried by several people.
- Always lift the centrifuge at both sides on the bottom plate.

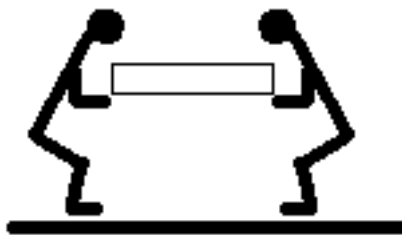

**Figure 2-1.** Lifting the centrifuge at both sides.

- The centrifuge can be damaged by impacts.



**CAUTION** Refrigerated centrifuges must be left idle at the new location for about an hour in order for the coolant to settle in the compressor. Do not start the centrifuge in the time.

## Location

The centrifuge should only be operated indoors.

The set-up location must fullfil the following requirements:

- A safety zone of at least 30 cm must be maintained around the centrifuge.  
People and hazardous substances must be kept out of the safety zone while centrifuging.



- The supporting structure must be stable and free of resonance, for example a level laboratory bench.
- The supporting structure must be suitable for horizontal setup of the centrifuge.
- The location must be free of grease and dust.
- The centrifuge should not be exposed to heat and strong sunlight.



**WARNING** UV rays reduce the stability of plastics.  
Do not subject the centrifuge, rotors and plastic accessories to direct sunlight.

- The set-up location must be well-ventilated at all times.

## Aligning the centrifuge

The horizontal alignment of the centrifuge must be checked every time after moving it to a different location.

The supporting structure must be suitable for horizontal setup of the centrifuge.



**CAUTION** If the centrifuge isn't level, imbalances can occur and the centrifuge can be damaged.  
Do not place anything under the centrifuge to level.

## Mains Connection

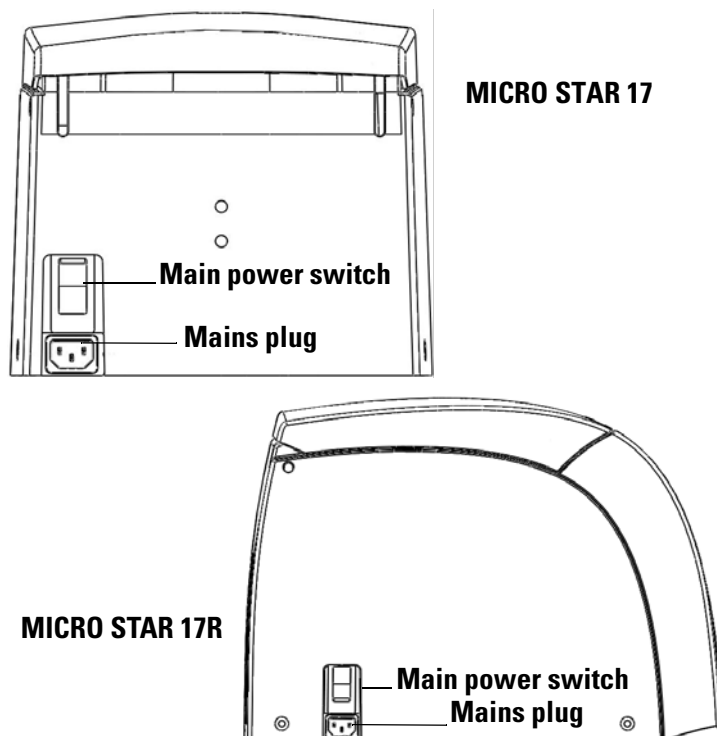

**Figure 2-2.** Mains connection

## 2 Before use

### Storage

1. To turn off the centrifuge put the mains switch to "0".
2. Plug the centrifuge into grounded electrical sockets only.

**Note** The centrifuge must be connected directly to the socket. Extension cords and multiple sockets are not allowed.

3. Check whether the cable complies with the safety standards of your country.
4. Make sure that the voltage and frequency correspond to the figures on the rating plate. Establish the connection to the power supply with the connecting cable.

## Storage

- Before storing the centrifuge and the accessories it must be cleaned and if necessary disinfected and decontaminated.
- Store the centrifuge in a clean, dust-free location.
- Be sure to place the centrifuge on its feet.
- Avoid direct sunlight.

## Control panel and keys

### Contents

- “Control panel” on page 3-2
- “Keys” on page 3-3

## Control panel

In the control panel you find the keys and displays of the centrifuge. All parameters can be selected and changed during operation.

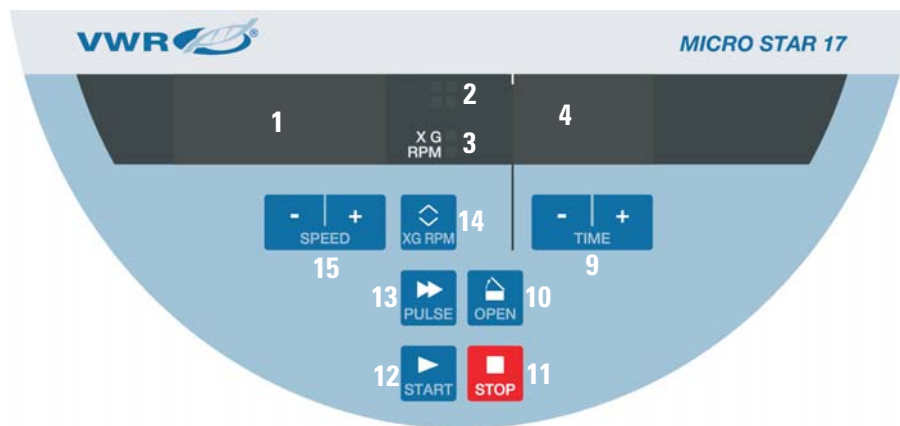
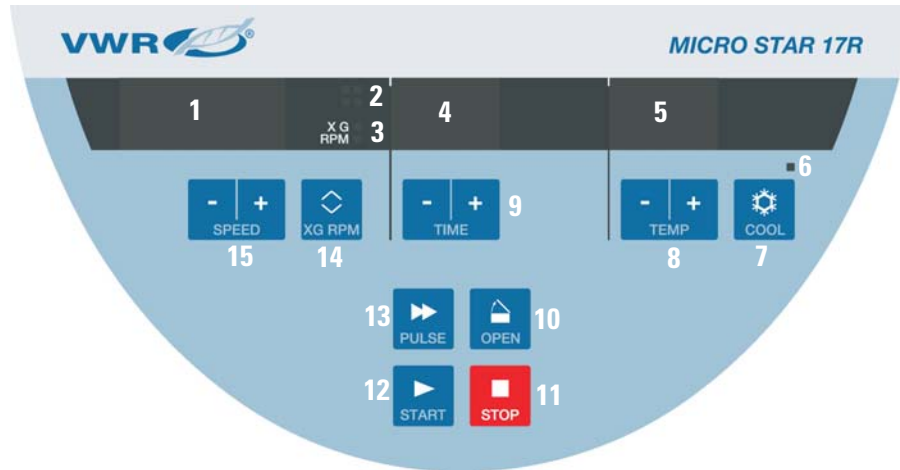











No	Description
1	Display for speed / RCF value
2	LED (lights up and moves during a run)
3	LED for speed / RCF value
4	Display for run time
5	Display for temperature
6	LED for pretemp function
7	PreTemp
8	Key for temperature setting
9	Key for run time setting
10	Open lid
11	Stop
12	Start

No	Description
13	Pulse
14	Toggle between speed / RCF value
15	Key for speed / RCF value setting

## Keys

The keys allow user intervention for controlling the operating mode as follows:

Key	Display contents
 <b>Start</b>	Normal start of the centrifuge
 <b>Stop</b>	End run manually
 <b>Open lid</b>	Automatic release (possible only when device is switched on). Emergency release (see <a href="#">“Mechanical emergency lid release”</a> on <a href="#">page 7-2</a> ).
 <b>Pulse</b>	By pressing the  key the centrifuge starts immediately and accelerates up to the end speed. Releasing the key initiates a stopping process at the highest braking curves.
	By pressing the  key up and down you change the value in the display. If you hold the key pressed, the display changes continuously at first slowly and after a few seconds at an accelerated pace to the higher or lower values. By pressing the key briefly, you increase or decrease the speed in one step. When pressing both arrows the cursor moves to the left.
 <b>Changing the display mode</b>	By pressing the  key you toggle between the display for speed and RCF value.
 <b>PreTemp</b>	By pressing the  key you start the pretemp function of the centrifuge.

# Introduction and description

## Contents

- “Switch on centrifuge” on page 4-2
- “Door opening” on page 4-2
- “Close door” on page 4-2
- “Rotor installation” on page 4-2
- “Entering parameters” on page 4-4
- “Centrifugation” on page 4-7
- “Short-term centrifugation” on page 4-8
- “Removing the rotor” on page 4-8
- “Aerosol-tight rotors” on page 4-9
- “Audible alarm” on page 4-9
- “Turning off the centrifuge” on page 4-9

## 4 Introduction and description

Switch on centrifuge

### Switch on centrifuge

1. Switch on the centrifuge.

The centrifuge shows the actual value in the display. Speed and runtime show **0**. The display shows the current temperature of the sample.

### Door opening

1. Press the  key.

The display shows the following message:



**Note** Use the emergency release only for malfunctions and power failures (see “[Mechanical emergency lid release](#)” on [page 7-2](#)).

### Close door

1. Close the door by pressing down on it lightly in the middle or on both sides of it.

**Note** The door should audibly click into place.



**CAUTION** Do not slam the door.

### Rotor installation



**CAUTION** Unapproved or incorrectly combined accessories can cause serious damage to the centrifuge.

Proceed as follows:

1. Open the lid of the centrifuge and if necessary remove any dust, foreign objects or residue from the chamber.

Thread and o-ring must be clean and undamaged.



**CAUTION** Do not install the rotor when the temperature difference between shaft and rotor lock is  $>20$  °C. Otherwise the rotor might jam during the installation. A jammed rotor can lead to damages of centrifuge and rotor.

2. Hold the rotor over the centrifuge spindle. The two bars in the labeling on the upper side of the rotor (a) must be above the retaining pin (b) of the centrifuge spindle.

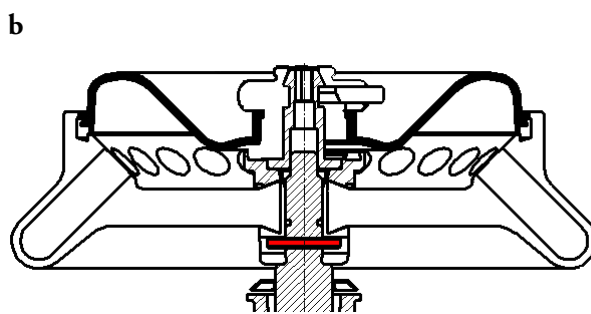
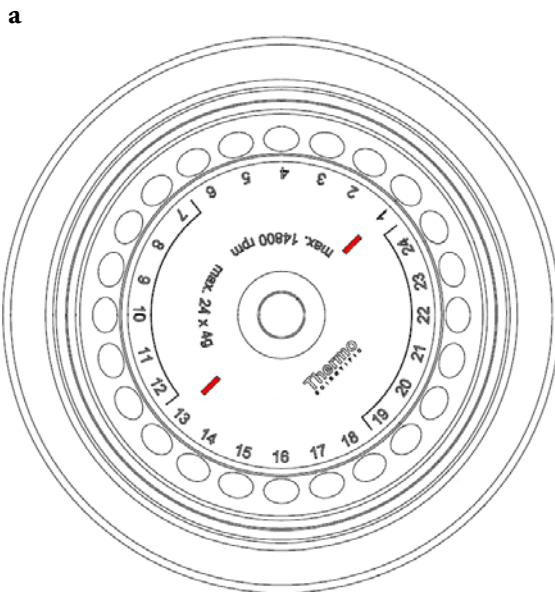

3. Let the rotor slide slowly down the centrifuge spindle.



**CAUTION** Do not force the rotor onto the centrifuge spindle. If the rotor is very light, then it may be necessary to press it onto the centrifuge spindle with a bit of pressure.

4. Thread the fastening tool into the centrifuge spindle clockwise. Hold the rotor with the other hand into position.
5. Close the rotor.
6. Check if the rotor is properly installed by lifting it slightly on the handle.



**WARNING** Check for any damage to the rotor: Damaged rotors must not be used. Keep the centrifuge spindle area of the rotor clear of objects.



**CAUTION** Check that the rotor is properly locked on the centrifuge spindle before each use by pulling it at its handle. Fasten the rotor if necessary.



## 4 Introduction and description

### Entering parameters



Be sure to check all seals before starting any aerosol-tight applications.



See the information in the rotor instruction manual.

7. The display shows:

## Entering parameters

**Note** Due to limited display digits there is a need to round the values. The direct comparison between the two values speed and RCF is therefore restricted.

### Select speed or RCF value

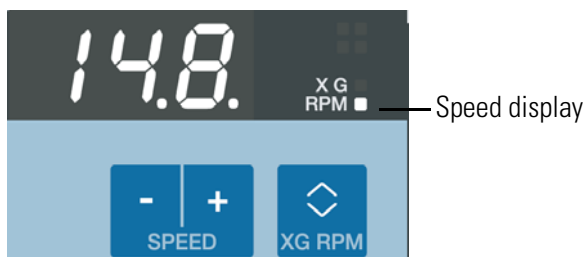

1. Press the  key under the left display. When the lower indicator is lit the display shows the speed. Press the  key to toggle between the two modes.



2. When the upper indicator is lit the display shows the RCF value. Press the  key to toggle between the two modes.





### Preselecting speed

1. Enter the desired value by pressing the key  repeatedly, until the desired value shows. You can adjust the speed in 100 rpm increments.
2. Press the  key to confirm the preselected value. If you do not press any key, the display flashes for a few seconds. The new preselected value is now stored and the display shows the actual value.

**Note** The centrifuge speed can be set to a minimum of 300 rpm. The maximum speed depends on the centrifuge variant.

## Preselecting RCF

1. Enter the desired value by pressing the key  repeatedly, until the desired value shows.  
You can adjust the RCF preselected value in steps of 100 xg.
2. Press the  key to confirm the preselected value.  
If you do not press any key, the display flashes for a few seconds. The new preselected value is now stored and the display shows the actual value.

**Note** The RCF value can be set to a minimum of 100 xg.  
The maximum speed depends on the centrifuge variant.  
The displayed RCF value is always corresponding to the maximum of centrifuge radius.

## Explanation of RCF value

The relative centrifugal force (RCF) is given as a multiple of the force of gravity g. It is a unitless numerical value which is used to compare the separation or sedimentation capacity of various centrifuges, since it is independent of the type of device. Only the centrifuging radius and the speed come into play in it:

$$\text{RCF} = 11,18 \times \left\langle \frac{n}{1000} \right\rangle^2 \times r$$

r = centrifuging radius in cm

n = rotational speed in rpm



The maximum RCF value is related to the maximum radius of the tube opening.

Remember that this value is reduced depending on the tubes and adapters used.

This can be accounted for in the calculation above if required.

## Run time preselection

**Note** You can select a run time between 1 and 99 min or continuous operation.

1. Enter the desired value by pressing the key  below the display in the middle repeatedly, until the desired value shows.  
You can adjust the run time in steps of 1 min.
2. Press the  key to confirm the preselected value.  
If you do not press any key, the display flashes for a few seconds. The new preselected value is now stored and the display shows the actual value.

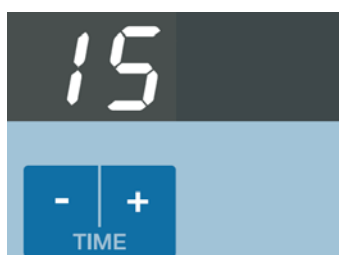



## 4 Introduction and description

### Entering parameters

#### Continuous operation

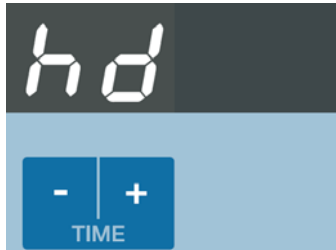
1. Press the  key until **hd** is shown.





2. During continuous operation, the centrifuge will continue running until you stop it manually with the  key.



**CAUTION** Please note that the lifetime of particularly plastic rotor tubes is limited. Continuous operation (extended use) may cause damage to them.

#### Preselecting the temperature

You can determine the sample temperature in °C. Proceed as follows:

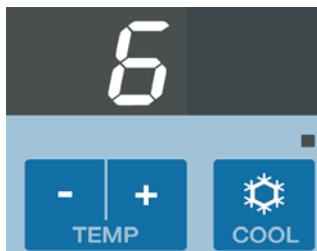

1. Enter the desired value by pressing the key  under the right display repeatedly, until the desired value shows.  
You increase or decrease the temperature in steps of 1 °C.
2. Press the  key to confirm the preselected value.  
If you do not press any key, the display flashes for a few seconds. The new preselected value is now stored and the display shows the actual value.





3. The display shows:
4. Restart the centrifuge.  
The refrigeration starts operating if the pre-selected temperature is below the current temperature of the rotor chamber.

#### Prewarming or precooling the centrifuge

In order to pretemp the centrifuge and the unloaded rotor proceed as follows:

1. Press the  key.  
An indicator above the  key indicates operation at the activated pretemp function.





2. Enter the desired value by pressing the key  under the right display repeatedly, until the desired value shows.  
You increase or decrease the temperature in steps of 1 °C.
3. Press the  key.  
The rotor will be operated at optimal speed.

**Note** When you press a different key than the  key you will quit the pretemp function.

**Note** If you wish to change the temperature of your samples, please consider that the time required for temperature adjustment is prolonged. For critical applications you should take other precautions to ensure that the desired temperature is actually reached and maintained.

### Changing the settings during the run

You can change the settings during the run as follows:

1. Press one of the three  keys in the control panel.  
The current value will switch into the preselecting value mode.
2. Enter the new value as described above.
3. Press the  key.  
The value is taken over immediately.

## Centrifugation

Once the rotor has been properly installed, the main switch has been turned on and the lid has been closed, you can start centrifuging.

### Starting centrifuge program

Press the  key on the control panel. The centrifuge accelerates to the preset speed with the time display active.

The run display begins to count down from the preselected value. If the remaining run time is less than 1 minute, the remaining time is given in seconds.

The circulating indicators in the left display represent the spinning rotor.

In continuous operation the time display counts up. The displayed run time is first in seconds. After one minute the displays changes every minute.

## Stopping the centrifugation program

### With preset run time



If the run time has been pre-selected, and all you have to do, is to wait until the centrifuge terminates the run automatically.

As soon as the speed drops to zero, the message **END** will appear in the display. By pressing the  key, you can open the lid and remove the centrifuge material.

You can also stop the centrifuging program manually at any time by pressing the  key.

### Continuous operation

If you selected continuous operation (see “Continuous operation” on page 4-6), you will have to stop the centrifuge manually.

1. Press the  key on the control panel.  
The centrifuge will be decelerated at the designated rate.
2. Press the  key to open the centrifuge door and the remove the samples when the message **END** appears in the display.

## Short-term centrifugation

For short-term centrifuging, the VWR MICRO STAR 17 / 17R has a PULSE- function.

By holding down the  key, spinning will start and continue until the key is let go.

The centrifuge accelerates and brakes at maximum power. The pre-selected value is ignored.

**Note** The centrifuge accelerates to the maximum speed.  
Check carefully whether you have to maintain a certain speed for your application.

The displayed run time is first in seconds. After one minute the displays changes every minute.

After an short-term centrifugation the set values are restored.

## Removing the rotor

To remove the rotor, proceed as follows:

1. Open the centrifuge lid.
2. Unscrew the rotor with the Allen wrench.
3. Grab the rotor in the middle. Pull the rotor directly upwards and remove it from the centrifuge spindle. Make sure not to tilt the rotor while doing this.



**WARNING** Be careful, when you change a rotor after a run. Centrifuge spindle and motor bearing assembly can be hot (>55 °C).

## Aerosol-tight rotors

When using an aerosol tight lid the rotor can be removed with the lid closed. This is to protect you and the samples.

## Audible alarm

### Error

Accompanying all error messages, a warning signal is given out.

Press any key to silence the warning signal.

### End of run

By default there is an acoustic signal at the end of any centrifugation run. To switch off this signal proceed as follows:



Press the  key when you turn on the centrifuge.

The display shows:



or



4. Press the  key under the display in the middle.  
The acoustic signal is turned on or off.
5. Press the  key to confirm the pre-selected value.

## Turning off the centrifuge

1. To turn off the centrifuge put the mains switch to "0".

**Note** The centrifuge is equipped with a special switch for balancing potential voltage discrepancies in the power grid. After pressing the mains switch the display therefore may still flash up to 10 seconds.

# Rotor Information

## Contents

- “Rotor Data” on page 5-2
- “Rotor Accessories” on page 5-2
- “Rotor Life-time” on page 5-2
- “Rotor Installation” on page 5-3
- “Aerosol-tight Applications” on page 5-5
- “Basic Principles” on page 5-5
- “Fill Level” on page 5-6
- “Checking the Aerosol-Tightness” on page 5-6

## Rotor Data

Centrifuge	MICRO STAR 17	MICRO STAR 17R
Catalog number	521 -1646	521 -1647
Places / Volume	24x 1.5 / 2ml	24x 1.5 / 2ml
maximum permissible load [ g ]	24x4	24x4
maximum speed $n_{max}$ [ rpm ]	13300	13300
Maximum RCF-value at $n_{max}$	17000	16800
Radius max. / min. [ cm ]	8.6 / 5.1	8.6 / 5.1
Angle [ ° ]	45	45
Accel. / braking time [ s ]	11 / 12	10 / 12
Permissible temperature range	-9°C to +40°C	-9°C to +40°C
Sample heating at $n_{max}$ [°C] referred to ambient temperature of 23°C, running time 60 minutes	33	≤0
aerosol-tight	yes*	yes*
autoclavable	121°C (20 Cycles)	121°C (20 Cycles)

\* Tested and approved by HPA, Porton-Down, UK

## Rotor Accessories

	Max. Dimensions x Length / [ mm ]	Tube capacity [ ml ]	Number per set	Color	Article Number
Reduction Sleeve PRC	6.2 x 20	0.2	24	grey	521 -1655
Reduction Sleeve	8 x 43.5	0.5 / 0.6	24	turquoise	521 -1657
Reduction Sleeve	6 x 46	0.25 / 0.4	24	red	521 -1656

## Rotor Life-time



**CAUTION** Rotors and accessories made of plastic should be exposed to direct sunlight. If the rotor shows signs of decoloration, deformation, wear or imbalance it must be replaced.



## Rotor Installation



**CAUTION** Unapproved or incorrectly combined accessories can cause serious damage to the centrifuge.

Proceed as follows:

1. Open the lid of the centrifuge and if necessary remove any dust, foreign objects or residue from the chamber.

Thread and o-ring must be clean and undamaged.



**CAUTION** Do not install the rotor when the temperature difference between shaft and rotor lock is  $>20^{\circ}\text{C}$ . Otherwise the rotor might jam during the installation. A jammed rotor can lead to damages of centrifuge and rotor.

2. Hold the rotor over the centrifuge spindle. The two bars in the labeling on the upper side of the rotor (a) must be above the retaining pin (b) of the centrifuge spindle.

a

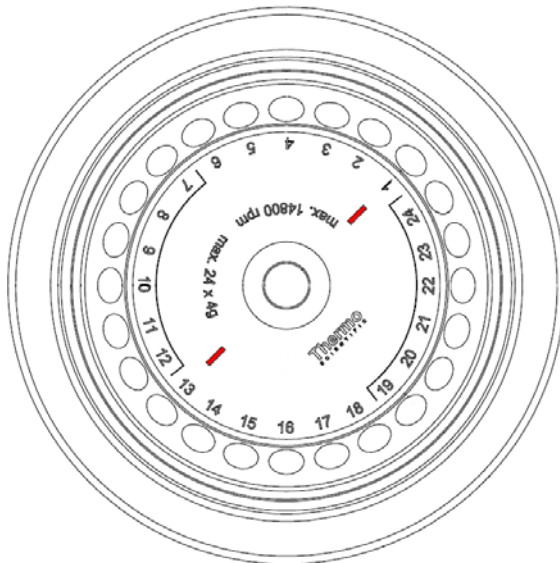

b

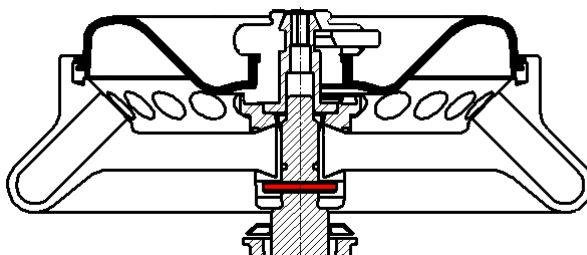

3. Let the rotor slide slowly down the centrifuge spindle.



**CAUTION** Do not force the rotor onto the centrifuge spindle. If the rotor is very light, then it may be necessary to press it onto the centrifuge spindle with a bit of pressure.

4. Thread the fastening tool into the centrifuge spindle clockwise. Hold the rotor with the other hand into position.
5. Close the rotor.  
The lid should audibly click into place.



**CAUTION** If the lid will not lock or it locks only with difficulty, the seals must be checked for proper fit and dirt. Clean the seals and lubricate the slightly. Check the lid mechanism for dirt and proper functionality.

6. Check if the rotor is properly installed by lifting it slightly on the handle.



**WARNING** Check for any damage to the rotor: Damaged rotors must not be used. Keep the centrifuge spindle area of the rotor clear of objects.



**CAUTION** Check that the rotor is properly locked on the centrifuge spindle before each use by pulling it at its handle. Fasten the rotor.



Be sure to check all sealings before starting any aerosol-tight applications.

See the information in the rotor instruction manual.

7. Close the centrifuge door.

## Operating the Rotor without Lid

If you plan to operate the rotor without the lid you must remove the seals.





**CAUTION** When operating the rotor without the lid the seals are not fixed in their position and can damage the centrifuge.

Always close the tube caps. Open caps can tear off during operation and cause damage.

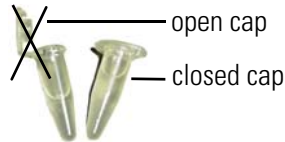

## Aerosol-tight Applications

### Basic Principles



**CAUTION** Aerosol-tight rotors and tubes may only be opened in an approved safety work-bench when centrifuging dangerous samples. Mind the maximum permissible load.



**WARNING** Be sure to check all sealings before starting any aerosol-tight applications.

- Check that the sample containers are well suited for the desired centrifugation process.
- Gravitation fields up to 21100xg.
- The temperature in ventilated centrifuges can reach 15°C above room temperature.

Prior to each use, the seals in the rotor are to be inspected in order to assure that they are correctly seated.

Prior to each use, the seals are to be inspected in order to assure that they are not worn or damaged, lubricate them slightly.

Always use the supplied grease when lubricating the seals.

Damaged seals must be replaced immediately.

Replacement seals are supplied with the rotor or can be order as spare part.

## Replace Seals

Follow the steps below:

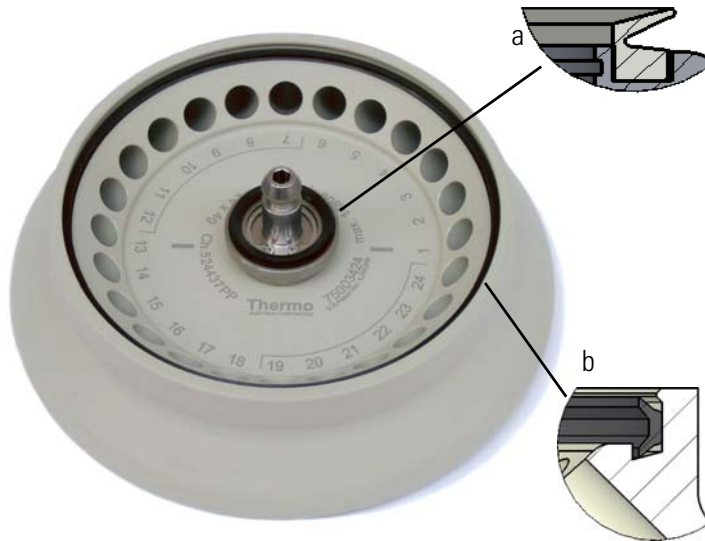

Lubricate all seals.

Press the smaller V-seal into the groove of the rotor collar (a).

Press the larger C-seal in the outer groove of the rotor body (b).

When loading the rotor, ensure that the rotor lid closes securely.

When the rotor lid is damaged or dulled it needs to be replaced.

## Fill Level

The tubes are only to be filled to a level which ensures that the sample is unable to reach the top of the tube during centrifugation.

Nominal volume	Permissible volume
2.0ml	1.5ml
1.5ml	1.0ml
others	2/3 of nominal volume

## Checking the Aerosol-Tightness

The aerosol tightness testing of the rotors and buckets depend on the microbiological test process in accordance with the EN 61010-2-020 Appendix AA.

Whether or not a rotor is aerosol-tight depends primarily on proper handling.

Check as needed to make sure your rotor is aerosol-tight.

The careful inspection of the seals and seal surfaces for signs of wear and damage such as cracks, scratches and embrittlement is extremely important.

Aerosol-tight applications are not possible if the lids are open.

Aerosol-tightness requires the correct operation when filling the sample vessels and closing the rotor lid.

## Quick Test

As a quick test, it is possible to test the aerosol-tightness of fixed-angle rotors using the following process:

1. Lubricate all seals lightly.  
Always use the supplied grease when lubricating the seals.
2. Fill the cavities with approx. 10ml of carbonated mineral water.
3. Close the rotor as explained in the handling instructions.
4. Shake the rotor vigorously using your hands.  
This releases the carbonic acid gas which is bound in the water, resulting in excess pressure. Do not apply pressure to the lid when doing so.

Leaks can be detected by escaping water or the sound of escaping gas.

Replace the seals if you detect any leaks. Then repeat the test.

5. Dry the rotor, rotor lid and the cover seal.

## Maintenance and care

### Contents

- “Cleaning intervals” on page 6-2
- “Cleaning” on page 6-2
- “Disinfection” on page 6-4
- “Decontamination” on page 6-5
- “Autoclaving” on page 6-5
- “Service of VWR” on page 6-6
- “Shipping and deposing of accessories” on page 6-6

## Cleaning intervals

For the sake of personal, environmental, and material protection, it is your duty to clean and if necessary disinfect the centrifuge on a regular basis.

Maintenance	Recommended interval
Clean rotor chamber	daily or when polluted
Clean rotor	daily or when polluted
Accessories	daily or when polluted
Cabinet	Once per month
Filter unit	Every three months
Ventilation holes	Every six months



**CAUTION** Refrain from using any other cleaning or decontamination procedure than those recommended here, if you are not entirely sure that the intended procedure is safe for the equipment.  
Use only approved cleansers.  
If in doubt, contact VWR.

## Cleaning

When cleaning centrifuge and accessories mind the following:

- Use warm water with a neutral solvent.
- Never use caustic cleaning agents such as soap suds, phosphoric acid, bleaching solutions or scrubbing powder.
- Rinse the cavities out thoroughly.
- Use a soft brush without metal bristles to remove stubborn residue.
- Afterwards rinse with distilled water.
- Place the rotors on a plastic grate with their cavities pointing down.
- If drying boxes are used, the temperature must never exceed 50 °C, since higher temperatures could damage the material and shorten the lifetime of the parts.
- Use only disinfectants with a pH of 6-8.



**CAUTION** Before using any cleaning or decontamination methods except those recommended by the manufacturer, users should check with the manufacturer that the proposed method will not damage the equipment.

Clean centrifuge and accessories as follows:

1. Open the centrifuge.
2. Turn off the centrifuge.

3. Pull out the power supply plug.
4. Release the rotor.
5. Grasp the rotor with both hands and lift it vertically off the centrifuge spindle.
6. Remove the centrifuge tubes and adapters.
7. Remove the seals.
8. Use a neutral cleaning agent with a pH value between 6 and 8 for cleaning.
9. Dry all of the rotors and accessories after cleaning with a cloth or in a warm air cabinet at a maximum temperature of 50 °C.
10. Observe “Replace seals” on page 5-6 when replacing the seals.



**CAUTION** When cleaning, do not allow liquids, especially organic solvents, to get on the drive shaft or the bearings of the centrifuge. Organic solvents break down the grease in the motor bearing. The drive shaft could freeze up.

After some applications there might be ice in the rotor chamber. Let the ice melt and drain it off. Clean the rotor chamber as described above.

## Cleaning filter unit

1. The VWR MICRO STAR 17R have a filter unit to protect the cooling device.

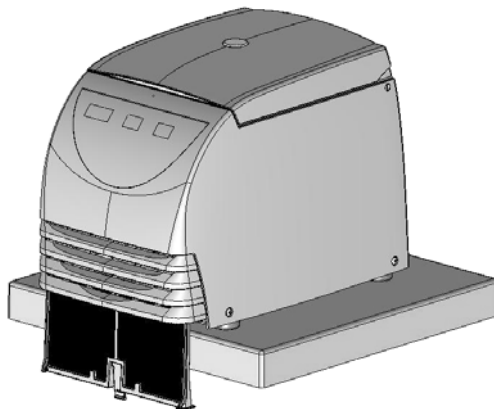

- Pull the centrifuge to the edge of the table.
2. Pull the clip below the sucking grid and remove the filter unit completely by pulling it down.
  3. Remove the cumulated dust with a soft cloth.
  4. Inserting the filter again. The labeling **Front** must show to the front of the centrifuge.
  5. Push the filter upwards into the slot until the clip locks in the bottom plate.



## Disinfection

Disinfect the centrifuge immediately whenever infectious material has spilled during centrifugation.



**WARNING** Infectious material can get into the centrifuge when a tube breaks or as a result of spills. Keep in mind the risk of infection when touching the rotor and take all necessary precautions.

In case of contamination, make sure that others are not put at risk.

Decontaminate the affected parts immediately.

Take other precautions if need be.

The rotor chamber and the rotor should be treated preferably with a neutral disinfectant.



**CAUTION** Before using any cleaning or decontamination methods except those recommended by the manufacturer, users should check with the manufacturer that the proposed method will not damage the equipment.

Observe the safety precautions and handling instructions for the cleaning agents used.

Contact the Service Department of VWR for questions regarding the use of other disinfectants.

Disinfect the rotor and accessories as follows:

1. Open the centrifuge.
2. Turn off the centrifuge.
3. Pull out the power supply plug.
4. Release the rotor.
5. Grasp the rotor with both hands and lift it vertically off the centrifuge spindle.
6. Remove the centrifuge tubes and adapters and dispose of them or disinfect them.
7. Treat the rotor and accessories according to the instructions for the disinfectant. Adhere strictly to the given application times.
8. Be sure the disinfectant can drain off the rotor.
9. Rinse the rotor and accessories thoroughly with water.
10. Dispose of the disinfectant according to the applicable guidelines.
11. Dry all of the rotors and accessories after cleaning with a cloth or in a warm air cabinet at a maximum temperature of 50 °C.

## Decontamination

Decontaminate the centrifuge immediately whenever radioactive material has spilled during centrifugation.



**WARNING** Infectious material can get into the centrifuge when a tube breaks or as a result of spills. Keep in mind the risk of infection when touching the rotor and take all necessary precautions.  
In case of contamination, make sure that others are not put at risk.  
Decontaminate the affected parts immediately.  
Take other precautions if need be.



**CAUTION** Before using any cleaning or decontamination methods except those recommended by the manufacturer, users should check with the manufacturer that the proposed method will not damage the equipment.

For general radioactive decontamination use a solution of equal parts of 70% ethanol, 10% SDS and water.

1. Open the centrifuge.
2. Turn off the centrifuge.
3. Pull out the power supply plug.
4. Release the rotor.
5. Grasp the rotor with both hands and lift it vertically off the centrifuge spindle.
6. Remove the centrifuge tubes and adapters and dispose of them or disinfect them.
7. Rinse the rotor first with ethanol and then with de-ionized water.
  - Adhere strictly to the given application times.
8. Be sure the decontamination solution can drain off the rotor.
9. Rinse the rotor and accessories thoroughly with water.
10. Dispose of the decontamination solution according to the applicable guidelines.
11. Dry all of the rotors and accessories after cleaning with a cloth or in a warm air cabinet at a maximum temperature of 50 °C.

## Autoclaving

1. Before autoclaving clean rotor and accessories as described above.
2. Place the rotor on a flat surface.
  - Rotors and adapter can be autoclaved at 121 °C.

- The maximum permissible autoclave cycle is 20 minutes at 121 °C.

**Note** No chemical additives are permitted in the steam.



**CAUTION** Never exceed the permitted temperature and duration when autoclaving. If the rotor shows signs of corrosion or wear, it must be replaced.

## Service of VWR

VWR recommends having the centrifuge and accessories serviced once a year by an authorized service technician. The service technicians check the following:

- the electrical equipment
- the suitability of the set-up site
- the lid lock and the safety system
- the rotor
- the fixation of the rotor and the drive shaft

VWR offers a warranty period of 2 (two) years for the MICRO STAR 17 / 17R.

## Shipping and depositing of accessories



**WARNING** Before shipping or depositing centrifuges and accessories you have to clean and if necessary disinfect or decontaminate everything.

# Troubleshooting

## Contents

- “Mechanical emergency lid release” on page 7-2
- “Troubleshooting by user” on page 7-3
- “When to contact customer service” on page 7-6

## Mechanical emergency door release

During a power failure, you will not be able to open the centrifuge door with the regular electric door release. A mechanical override is provided to allow sample recovery in the case of an emergency. However, this should be used only in emergencies and after the rotor has come to a complete stop.



**WARNING** The rotor can still be spinning at high speed. If touched, it can cause serious injuries.

Always wait a few minutes until the rotor has come to a stop without braking. The brake does not work when there is no current. The braking process lasts much longer than usual.

Proceed as follows:

1. Make sure the rotor has stopped (view port in the lid).



**WARNING** Never use your hand or other tools to brake the rotor.

2. Pull out the power supply plug.
3. Insert a 8 cm (3 inch) long wire (e.g. a staple) into the hole above the control panel.
4. Press the centrifuge door down gently. Push the wire further into the hole until you hear and feel the door latch unlocking.
5. Remove the wire from the hole and open the centrifuge door.  
Now you can remove your samples.

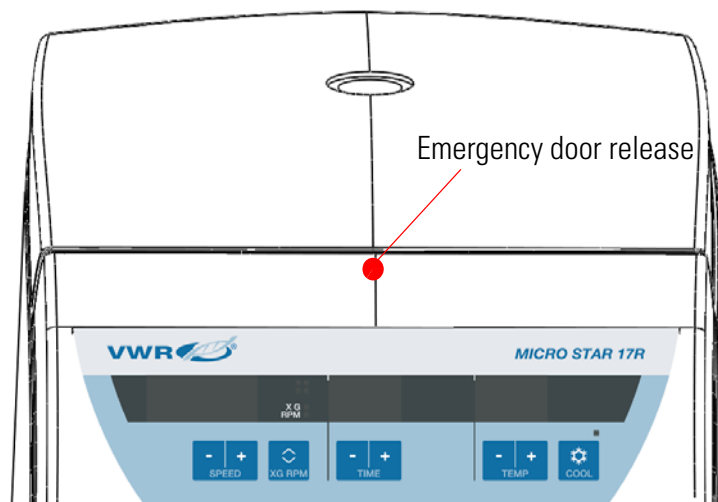



**Figure 7-1.** Emergency door release

Reconnect the centrifuge once the power has been restored. Switch on the centrifuge.

## Troubleshooting by user



If problems occur other than those listed in this table, the authorized customer service representative must be contacted.

Failure message	Problem with centrifuge	Possible causes and cures
Display remains dark.	The drive stops. The centrifuge decelerates without braking. The centrifuge door can not be opened.	No mains connection 1. Is the centrifuge turned on? 2. Check the mains connection. If the display remains dark, inform Customer Service.
Display fails briefly	The drive stops. The drive stops. The centrifuge decelerates without braking.	Mains connection interrupted for some seconds. 1. Turn off mains switch. 2. Check whether the mains power cord is connected properly. 3. Restart the centrifuge. Restart the centrifuge.
The centrifuge door cannot be opened.	Pressing  key has no effect.	Centrifuge door is not correctly engaged or warped. 1. Check if mains connection is working and the instrument is switched on (display is lit). 2. If this is unsuccessful, you may open the centrifuge door using the mechanical emergency door release ("Mechanical emergency lid release" on page 7-2)
	Exceptionally running noise	Imbalance 1. Stop the centrifuge. Press the  key or unplug mains powercord. 2. Wait until the centrifuge comes to a complete stop. 3. Check whether the rotor is properly loaded. Check whether a broken tube, damage to the rotor or motor is responsible for the run noise. If the running noise remains exceptionally, inform Customer Service.
Display <b>oP</b> appears although lid is closed.	Centrifuge does not start.	Centrifuge door not properly closed. Open the centrifuge door and repeat locking procedure. If the message appears again, inform Customer Service.
<b>Lid</b>	Rotor stops with deceleration to standstill.	Centrifuge door was opened manually during the run. Close centrifuge door immediately. Rotor stops with deceleration to standstill. For further centrifugation, you have to switch the instrument off and switch it on again
<b>bAL</b> (only VWR Micro Star)	Rotor stops with deceleration to standstill.	Imbalance switch releases. 1. Open the centrifuge by pressing the  key. 2. Check whether the rotor is properly loaded. 3. Check whether a broken tube or damaged rotor released the imbalance switch. If an error message appears again, inform Customer Service.

Failure message	Problem with centrifuge	Possible causes and cures
E-01 - E-13	Rotor stops with deceleration to standstill. The centrifuge cannot be operated.	Internal program error Switch the instrument off and on again. If an error message appears again, inform Customer Service.
E-14	Rotor stops with deceleration to standstill. The centrifuge cannot be operated.	Overtemperature in the centrifuge chamber. Switch the centrifuge off and turn it on again after approx. one minute. If an error message appears again, inform Customer Service.
E-15-E-16	Rotor stops with deceleration to standstill. The centrifuge cannot be operated.	Temperature measurement error Switch the instrument off and on again. If an error message appears again, inform Customer Service.
E-22 - E-23	Rotor stops with deceleration to standstill. The centrifuge cannot be operated.	Error in speed entry Switch the instrument off and on again. The display shows <b>BR</b> and a countdown from <b>100 - 0</b> . If an error message appears again, inform Customer Service.
E-24	The centrifuge cannot be operated. The door cannot be opened.	Wrong status information from the door latch. 1. Switch the instrument off and on again. 2. After re-switching on, the display shows <b>Lid FAIL</b> . 3. If the centrifuge door has been already opened, the display shows <b>CLOSE Lid</b> . Thereupon close the door. 4. The centrifuge tries to open the door to switch for starting the normal operation mode. If an error message appears again, inform Customer Service.
E-29	Motor does not start	Motor or rotor blocked 1. Switch the instrument off and on again using the mains switch. 2. Open the centrifuge door. 3. Check whether the rotor can turn freely. If an error message appears again, inform Customer Service.
E-31	Rotor stops without deceleration to standstill or does not start.	Overtemperature in the motor. 1. Turn instrument off and unplug mains power cord. 2. Check and clean the venting slots if necessary and respectively the filter unit of the cooled centrifuge. 3. After approx. 60 minutes you can restart the instrument. Observe the maximum permissible environmental temperature. If an error message appears again, inform Customer Service.

Failure message	Problem with centrifuge	Possible causes and cures
E-33	Rotor stops with deceleration to standstill.	<p>Overpressure in the refrigeration unit</p> <ol style="list-style-type: none"> <li>1. Wait 15 minutes before switching off the centrifuge. The fan will operate at maximum power in order to reduce the overpressure.</li> <li>2. Check the draft at the back of the centrifuge with you hand if you cannot here the fan.</li> </ol> <p>If you do not feel any draft:</p> <ol style="list-style-type: none"> <li>1. Turn instrument off and unplug mains power cord.</li> <li>2. Check and clean the venting slots if necessary and respectively the filter unit of the cooled centrifuge.</li> <li>3. After approx. 30 minutes you can restart the instrument.</li> </ol> <p>Observe the maximum permissible environmental temperature.</p> <p>If an error message appears again, inform Customer Service.</p>
E-36	Rotor stops with deceleration to standstill. The centrifuge cannot be operated.	<p>Over-current or over-voltage, the brake resistance the hot.</p> <p>After approx. 60 minutes you can restart the instrument.</p> <p>Switch the instrument off and on again.</p> <p>If an error message appears again, inform Customer Service.</p>
E-39	Rotor stops with deceleration to standstill. The centrifuge cannot be operated.	<p>Error in speed entry</p> <p>Switch the instrument off and on again.</p> <p>If an error message appears again, inform Customer Service.</p>
E-41 - E-56	Rotor stops with deceleration to standstill. The centrifuge cannot be operated.	<p>Internal program error</p> <p>Switch the instrument off and on again.</p> <p>If an error message appears again, inform Customer Service.</p>
E-60	Rotor stops with deceleration to standstill.	<p>Under-temperature in the centrifuge chamber.</p> <ol style="list-style-type: none"> <li>1. Stop the centrifugation run.</li> <li>2. Open the centrifuge door and defrost the chamber. Never touch the chamber directly with your hands – you may freeze up.</li> <li>3. After approx. 60 minutes you can restart the instrument.</li> </ol> <p>Observe the maximum permissible ambient temperature.</p> <ol style="list-style-type: none"> <li>4. If a strong ice sheet is present in the internal chamber, besure to remove all condensate after defrosting.</li> </ol> <p>If an error message appears again, inform Customer Service.</p>
E-63	Rotor stops with deceleration to standstill. The centrifuge cannot be operated.	<p>Temperature measurement error</p> <p>Switch the instrument off and on again.</p> <p>If an error message appears again, inform Customer Service.</p>
E-64	The cooling system could not be started.	<p>Power supply undervoltage</p> <p>Check the power supply and contact you supplier if necessary. The message <b>LINE</b> appears in the display.</p>
E-65	Rotor stops with deceleration to standstill. The centrifuge cannot be operated.	<p>Temperature measurement error</p> <p>Switch the instrument off and on again.</p> <p>If an error message appears again, inform Customer Service.</p>



# When to contact customer service

If you need to contact customer service, please provide the order no. and the serial no. of your centrifuge. This information can be found on the back near the inlet for the power supply cable.

To identify the software version, proceed as follows:

1. Hold down the  key and then switch on the centrifuge.  
In the display all segments are lit.
- Subsequently, the following readings will be displayed for 5 seconds each:

Software number	SOFT	058	3_
Software version		_01	
NV-RAM number	EEPRO	462	1_
NV-RAM version		_01	
Cycle counter	CYCLE	001	25

- The values shown above are just examples.

Software	0583 Version 01
NV-RAM	4521 Version 01
cycles completed	125

2. Communicate the software version to the service technician.

# Chemical Compatibility Chart

CHEMICAL	MATERIAL	ALUMINUM	ANODIC COATING for ALUMINUM	BUNA N	CELLULOSE ACETATE BUTYRATE	POLYURETHANE ROTOR PAINT	COMPOSITE Carbon Fiber/Epoxy	DELRIN	ETHYLENE PROPYLENE	GLASS	NEOPRENE	NORYL	NYLON	PET <sup>1</sup> , POLYCLEAR, CLEARCRIMP	POLYALLOMER	POLYCARBONATE	POLYESTER, GLASS THERMOSET	POLYETHERIMIDE	POLYRTHYLENE	POLYPROPYLENE	POLYSULFONE	POLYVINYL CHLORIDE	RULON A, TEFLON	SILICONE RUBBER	STAINLESS STEEL	TITANIUM	TYGON	VITON
2-mercaptoethanol		S	S	U	-	S	M	S	-	S	U	S	S	U	S	S	-	S	S	S	S	U	S	S	S	S	S	S
Acetaldehyde		S	-	U	U	-	-	-	M	-	U	-	-	-	M	U	U	U	M	M	-	M	S	U	-	S	-	U
Acetone		M	S	U	U	S	U	M	S	S	U	U	S	U	S	U	U	U	S	S	U	U	S	M	M	S	U	U
Acetonitrile		S	S	U	-	S	M	S	-	S	S	U	S	U	M	U	U	-	S	M	U	U	S	S	S	S	U	U
Alconox		U	U	S	-	S	S	S	-	S	S	S	S	S	S	M	S	S	S	S	S	S	S	S	S	S	S	U
Allyl Alcohol		-	-	-	U	-	-	S	-	-	-	-	S	-	S	S	M	S	S	S	S	-	M	S	-	-	S	-
Aluminum Chloride		U	U	S	S	S	S	U	S	S	S	S	M	S	S	S	S	-	S	S	S	S	S	M	U	U	S	S
Formic Acid (100%)		-	S	M	U	-	-	U	-	-	-	-	U	-	S	M	U	U	S	S	-	U	S	-	U	S	-	U
Ammonium Acetate		S	S	U	-	S	S	S	-	S	S	S	S	S	S	S	U	-	S	S	S	S	S	S	S	S	S	S
Ammonium Carbonate		M	S	U	S	S	S	S	S	S	S	S	S	S	S	U	U	-	S	S	S	S	S	S	M	S	S	S
Ammonium Hydroxide (10%)		U	U	S	U	S	S	M	S	S	S	S	S	-	S	U	M	S	S	S	S	S	S	S	S	S	M	S
Ammonium Hydroxide (28%)		U	U	S	U	S	U	M	S	S	S	S	S	U	S	U	M	S	S	S	S	S	S	S	S	S	M	S
Ammonium Hydroxide (conc.)		U	U	U	U	S	U	M	S	-	S	-	S	U	S	U	U	S	S	S	-	M	S	S	S	S	-	U
Ammonium Phosphate		U	-	S	-	S	S	S	S	S	S	S	S	-	S	S	M	-	S	S	S	S	S	M	S	S	S	
Ammonium Sulfate		U	M	S	-	S	S	U	S	S	S	S	S	S	S	S	S	-	S	S	S	S	S	S	U	S	S	U
Amyl Alcohol		S	-	M	U	-	-	S	S	-	M	-	S	-	M	S	S	S	S	M	-	-	-	U	-	S	-	M
Aniline		S	S	U	U	S	U	S	M	S	U	U	U	U	U	U	U	-	S	M	U	U	S	S	S	S	U	S
Sodium Hydroxide (<1%)		U	-	M	S	S	S	-	-	S	M	S	S	-	S	M	M	S	S	S	S	S	S	M	S	S	-	U
Sodium Hydroxide (10%)		U	-	M	U	-	-	U	-	M	M	S	S	U	S	U	U	S	S	S	S	S	S	M	S	S	-	U
Barium Salts		M	U	S	-	S	S	S	S	S	S	S	S	S	S	S	M	-	S	S	S	S	S	M	S	S	S	
Benzene		S	S	U	U	S	U	M	U	S	U	U	S	U	U	U	M	U	M	U	U	U	S	U	U	S	U	S
Benzyl Alcohol		S	-	U	U	-	-	M	M	-	M	-	S	U	U	U	U	U	U	U	-	M	S	M	-	S	-	S

# A Chemical Compatibility Chart

CHEMICAL	MATERIAL	ALUMINUM	ANODIC COATING for ALUMINUM	BUNA N	CELLULOSE ACETATE BUTYRATE	POLYURETHANE ROTOR PAINT	COMPOSITE Carbon Fiber/Epoxy	DELRIN	ETHYLENE PROPYLENE	GLASS	NEOPRENE	NORYL	NYLON	PET <sup>1</sup> , POLYCLEAR, CLEARCRIMP	POLYALLOMER	POLYCARBONATE	POLYESTER, GLASS THERMOSET	POLYETHERIMIDE	POLYETHYLENE	POLYPROPYLENE	POLYSULFONE	POLYVINYL CHLORIDE	RULON A, TEFLON	SILICONE RUBBER	STAINLESS STEEL	TITANIUM	TYGON	VITON
Boric Acid	U	S	S	M	S	S	S	U	S	S	S	S	S	S	S	S	S	U	S	S	S	S	S	S	S	S	S	
Cesium Acetate	M	-	S	-	S	S	S	-	S	S	S	S	-	S	S	-	-	S	S	S	S	S	S	S	M	S	S	S
Cesium Bromide	M	S	S	-	S	S	S	-	S	S	S	S	S	S	S	-	-	S	S	S	S	S	S	S	M	S	S	S
Cesium Chloride	M	S	S	U	S	S	S	-	S	S	S	S	S	S	S	-	-	S	S	S	S	S	S	S	M	S	S	S
Cesium Formate	M	S	S	-	S	S	S	-	S	S	S	S	S	S	S	-	-	S	S	S	S	S	S	S	M	S	S	S
Cesium Iodide	M	S	S	-	S	S	S	-	S	S	S	S	S	S	S	-	-	S	S	S	S	S	S	S	M	S	S	S
Cesium Sulfate	M	S	S	-	S	S	S	-	S	S	S	S	S	S	S	-	-	S	S	S	S	S	S	S	M	S	S	S
Chloroform	U	U	U	U	S	S	M	U	S	U	U	M	U	M	U	U	U	M	M	U	U	S	U	U	U	M	S	
Chromic Acid (10%)	U	-	U	U	S	U	U	-	S	S	S	U	S	S	M	U	M	S	S	U	M	S	M	U	S	S	S	
Chromic Acid (50%)	U	-	U	U	-	U	U	-	-	-	S	U	U	S	M	U	M	S	S	U	M	S	-	U	M	-	S	
Cresol Mixture	S	S	U	-	-	-	S	-	S	U	U	U	U	U	U	-	-	U	U	-	U	S	S	S	S	U	S	
Cyclohexane	S	S	S	-	S	S	S	U	S	U	S	S	U	U	U	M	S	M	U	M	M	S	U	M	M	U	S	
Deoxycholate	S	S	S	-	S	S	S	-	S	S	S	S	S	S	S	-	-	S	S	S	S	S	S	S	S	S	S	S
Distilled Water	S	S	S	S	S	S	S	S	S	S	S	S	S	S	S	S	S	S	S	S	S	S	S	S	S	S	S	S
Dextran	M	S	S	S	S	S	S	-	S	S	S	S	S	S	S	S	S	S	S	S	S	S	S	S	M	S	S	S
Diethyl Ether	S	S	U	U	S	S	S	U	S	U	U	S	U	U	U	U	U	U	U	U	U	S	S	S	S	M	U	
Diethyl Ketone	S	-	U	U	-	-	M	-	S	U	-	S	-	M	U	U	U	M	M	-	U	S	-	-	S	U	U	
Diethylpyrocarbonate	S	S	U	-	S	S	S	-	S	S	U	S	U	S	U	-	-	S	S	S	M	S	S	S	S	S	S	
Dimethylsulfoxide	S	S	U	U	S	S	S	-	S	U	S	S	U	S	U	U	-	S	S	U	U	S	S	S	S	U	U	
Dioxane	M	S	U	U	S	S	M	M	S	U	U	S	U	M	U	U	-	M	M	M	U	S	S	S	S	U	U	
Ferric Chloride	U	U	S	-	-	-	M	S	-	M	-	S	-	S	-	-	-	S	S	-	-	-	M	U	S	-	S	
Acetic Acid (Glacial)	S	S	U	U	S	S	U	M	S	U	S	U	U	U	U	U	M	S	U	M	U	S	U	U	S	-	U	
Acetic Acid (5%)	S	S	M	S	S	S	M	S	S	S	S	S	M	S	S	S	S	S	S	S	M	S	S	M	S	S	M	
Acetic Acid (60%)	S	S	U	U	S	S	U	-	S	M	S	U	U	M	U	S	M	S	M	S	M	S	M	U	S	M	U	
Ethyl Acetate	M	M	U	U	S	S	M	M	S	S	U	S	U	M	U	U	-	S	S	U	U	S	M	M	S	U	U	
Ethyl Alcohol (50%)	S	S	S	S	S	S	M	S	S	S	S	S	U	S	U	S	S	S	S	S	S	S	S	M	S	M	U	
Ethyl Alcohol (95%)	S	S	S	U	S	S	M	S	S	S	S	S	U	S	U	-	S	S	S	M	S	S	S	U	S	M	U	
Ethylene Dichloride	S	-	U	U	-	-	S	M	-	U	U	S	U	U	U	U	U	U	U	-	U	S	U	-	S	-	S	
Ethylene Glycol	S	S	S	S	S	S	S	S	S	S	S	S	-	S	U	S	S	S	S	S	S	S	S	M	S	M	S	
Ethylene Oxide Vapor	S	-	U	-	-	U	-	-	S	U	-	S	-	S	M	-	-	S	S	S	U	S	U	S	S	S	U	
Ficoll-Hypaque	M	S	S	-	S	S	S	-	S	S	S	S	-	S	S	-	S	S	S	S	S	S	S	M	S	S	S	

<b>CHEMICAL</b>	<b>MATERIAL</b>	ALUMINUM	ANODIC COATING for ALUMINUM	BUNAN	CELLULOSE ACETATE BUTYRATE	POLYURETHANE ROTOR PAINT	COMPOSITE Carbon Fiber/Epoxy	DELRIN	ETHYLENE PROPYLENE	GLASS	NEOPRENE	NORYL	NYLON	PET <sup>1</sup> , POLYCLEAR, CLEARCRIMP	POLYALLOMER	POLYCARBONATE	POLYESTER, GLASS THERMOSET	POLYETHERIMIDE	POLYETHYLENE	POLYPROPYLENE	POLYSULFONE	POLYVINYL CHLORIDE	RULON A, TEFLON	SILICONE RUBBER	STAINLESS STEEL	TITANIUM	TYGON	VITON	
Hydrofluoric Acid (10%)	U	U	U	M	-	-	U	-	-	U	U	S	-	S	M	U	S	S	S	S	M	S	U	U	U	-	-		
Hydrofluoric Acid (50%)	U	U	U	U	-	-	U	-	-	U	U	U	U	U	S	U	U	U	S	S	M	M	S	U	U	U	-	M	
Hydrochloric Acid (conc.)	U	U	U	U	-	U	U	M	-	U	M	U	U	M	U	U	U	-	S	-	U	S	U	U	U	-	-		
Formaldehyde (40%)	M	M	M	S	S	S	S	M	S	S	S	S	S	M	S	S	S	U	S	S	M	S	S	S	M	S	M	U	
Glutaraldehyde	S	S	S	S	-	-	S	-	S	S	S	S	S	S	S	S	-	-	S	S	S	-	-	S	S	S	-	-	
Glycerol	M	S	S	-	S	S	S	S	S	S	S	S	S	S	S	S	S	-	S	S	S	S	S	S	S	S	S	S	
Guanidine Hydrochloride	U	U	S	-	S	S	S	-	S	S	S	S	S	S	S	S	-	-	S	S	S	S	S	S	U	S	S	S	
Haemo-Sol	S	S	S	-	-	-	S	-	S	S	S	S	S	S	S	S	-	-	S	S	S	S	S	S	S	S	S	S	
Hexane	S	S	S	-	S	S	S	-	S	S	U	S	U	M	U	S	S	U	S	S	M	S	U	S	S	U	S	S	
Isobutyl Alcohol	-	-	M	U	-	-	S	S	-	U	-	S	U	S	S	M	S	S	S	-	S	S	S	-	S	-	S	S	
Isopropyl Alcohol	M	M	M	U	S	S	S	S	S	U	S	S	U	S	U	M	S	S	S	S	S	S	S	S	M	M	M	S	
Iodoacetic Acid	S	S	M	-	S	S	S	-	S	M	S	S	M	S	S	-	M	S	S	S	S	S	S	M	S	S	M	M	
Potassium Bromide	U	S	S	-	S	S	S	-	S	S	S	S	S	S	S	S	S	S	S	S	-	S	S	S	M	S	S	S	
Potassium Carbonate	M	U	S	S	S	S	S	-	S	S	S	S	S	S	U	S	S	S	S	S	S	S	S	S	S	S	S	S	
Potassium Chloride	U	S	S	-	S	S	S	S	S	S	S	S	S	S	S	-	S	S	S	S	S	S	S	U	S	S	S	S	
Potassium Hydroxide (5%)	U	U	S	S	S	S	M	-	S	S	S	S	-	S	U	S	S	S	S	S	S	S	S	M	U	M	S	U	
Potassium Hydroxide (conc.)	U	U	M	U	-	-	M	-	M	S	S	-	U	M	U	U	U	S	M	-	M	U	-	U	U	-	U		
Potassium Permanganate	S	S	S	-	S	S	S	-	S	S	S	U	S	S	S	M	-	S	M	S	U	S	S	M	S	U	S	S	
Calcium Chloride	M	U	S	S	S	S	S	S	S	S	S	S	S	S	M	S	-	S	S	S	S	S	S	M	S	S	S	S	
Calcium Hypochlorite	M	-	U	-	S	M	M	S	-	M	-	S	-	S	M	S	-	S	S	S	M	S	M	U	S	-	S	S	
Kerosene	S	S	S	-	S	S	S	U	S	M	U	S	U	M	M	S	-	M	M	M	S	S	U	S	S	U	S	S	
Sodium Chloride (10%)	S	-	S	S	S	S	S	S	-	-	-	S	S	S	S	S	-	S	S	S	S	-	S	S	M	-	S	S	
Sodium Chloride (sat'd)	U	-	S	U	S	S	S	-	-	-	-	S	S	S	S	S	-	S	S	-	S	-	S	S	M	-	S	S	
Carbon Tetrachloride	U	U	M	S	S	U	M	U	S	U	U	S	U	M	U	S	S	M	M	S	M	M	M	M	U	S	S	S	
Aqua Regia	U	-	U	U	-	-	U	-	-	-	-	-	-	U	U	U	U	U	U	U	-	-	-	-	-	-	S	-	M
Solution 555 (20%)	S	S	S	-	-	-	S	-	S	S	S	S	S	S	S	-	-	S	S	S	-	S	S	S	S	S	S	S	
Magnesium Chloride	M	S	S	-	S	S	S	S	S	S	S	S	S	S	S	S	S	S	S	S	S	S	S	M	S	S	S	S	
Mercaptoacetic Acid	U	S	U	-	S	M	S	-	S	M	S	U	U	U	U	-	S	U	U	S	M	S	U	S	S	S	S	S	
Methyl Alcohol	S	S	S	U	S	S	M	S	S	S	S	S	U	S	U	M	S	S	S	S	S	S	S	M	S	M	U	U	
Methylene Chloride	U	U	U	U	M	S	S	U	S	U	U	S	U	U	U	U	U	U	M	U	U	U	S	S	M	U	S	U	
Methyl Ethyl Ketone	S	S	U	U	S	S	M	S	S	U	U	S	U	S	U	U	U	U	S	S	U	U	S	S	S	S	U	U	

# A Chemical Compatibility Chart

CHEMICAL	MATERIAL	ALUMINUM	ANODIC COATING for ALUMINUM	BUNA N	CELLULOSE ACETATE BUTYRATE	POLYURETHANE ROTOR PAINT	COMPOSITE Carbon Fiber/Epoxy	DELRIN	ETHYLENE PROPYLENE	GLASS	NEOPRENE	NORLY	NYLON	PET <sup>1</sup> , POLYCLEAR, CLEARCRIMP	POLYALLOMER	POLYCARBONATE	POLYESTER, GLASS THERMOSET	POLYETHERIMIDE	POLYETHYLENE	POLYPROPYLENE	POLYSULFONE	POLYVINYL CHLORIDE	RULON A, TEFLON	SILICONE RUBBER	STAINLESS STEEL	TITANIUM	TYGON	VITON
Metrizamide	M	S	S	-	S	S	S	-	S	S	S	S	-	S	S	-	-	S	S	S	S	S	S	M	S	S	S	
Lactic Acid (100%)	-	-	S	-	-	-	-	-	-	M	S	U	-	S	S	S	M	S	S	-	M	S	M	S	S	-	S	
Lactic Acid (20%)	-	-	S	S	-	-	-	-	-	M	S	M	-	S	S	S	S	S	S	S	S	M	S	M	S	S	-	S
N-Butyl Alcohol	S	-	S	U	-	-	S	-	-	S	M	-	U	S	M	S	S	S	S	S	M	M	S	M	-	S	-	S
N-Butyl Phthalate	S	S	U	-	S	S	S	-	S	U	U	S	U	U	U	M	-	U	U	S	U	S	M	M	S	U	S	
N, N-Dimethylformamide	S	S	S	U	S	M	S	-	S	S	U	S	U	S	U	U	-	S	S	U	U	S	M	S	S	S	U	
Sodium Borate	M	S	S	S	S	S	S	S	S	S	S	S	U	S	S	S	S	-	S	S	S	S	S	M	S	S	S	
Sodium Bromide	U	S	S	-	S	S	S	-	S	S	S	S	S	S	S	S	S	-	S	S	S	S	S	M	S	S	S	
Sodium Carbonate (2%)	M	U	S	S	S	S	S	S	S	S	S	S	S	S	U	S	S	S	S	S	S	S	S	S	S	S	S	
Sodium Dodecyl Sulfate	S	S	S	-	S	S	S	-	S	S	S	S	S	S	S	-	S	S	S	S	S	S	S	S	S	S	S	
Sodium Hypochlorite (5%)	U	U	M	S	S	M	U	S	S	M	S	S	S	M	S	S	S	S	S	M	S	S	S	M	U	S	M	S
Sodium Iodide	M	S	S	-	S	S	S	-	S	S	S	S	S	S	S	S	-	-	S	S	S	S	S	M	S	S	S	
Sodium Nitrate	S	S	S	-	S	S	S	S	S	S	S	S	S	S	S	S	S	-	S	S	S	S	S	U	S	S	S	S
Sodium Sulfate	U	S	S	-	S	S	S	S	S	S	S	S	S	S	S	S	S	S	S	S	S	S	S	M	S	S	S	
Sodium Sulfide	S	-	S	S	-	-	-	S	-	-	-	S	S	S	U	U	-	-	S	-	-	-	S	S	M	-	S	
Sodium Sulfite	S	S	S	-	S	S	S	S	M	S	S	S	S	S	S	M	-	S	S	S	S	S	S	S	S	S	S	
Nickel Salts	U	S	S	S	S	S	-	S	S	S	-	-	S	S	S	S	-	S	S	S	S	S	M	S	S	S	S	
Oils (Petroleum)	S	S	S	-	-	-	S	U	S	S	S	S	U	U	M	S	M	U	U	S	S	S	U	S	S	S	S	
Oils (Other)	S	-	S	-	-	-	S	M	S	S	S	S	U	S	S	S	S	U	S	S	S	S	-	S	S	M	S	
Oleic Acid	S	-	U	S	S	S	U	U	S	U	S	S	M	S	S	S	S	S	S	S	S	S	M	U	S	M	M	
Oxalic Acid	U	U	M	S	S	S	U	S	S	S	S	S	U	S	U	S	S	S	S	S	S	S	S	U	M	S	S	
Perchloric Acid (10%)	U	-	U	-	S	U	U	-	S	M	M	-	-	M	U	M	S	M	M	-	M	S	U	-	S	-	S	
Perchloric Acid (70%)	U	U	U	-	-	U	U	-	S	U	M	U	U	M	U	U	U	M	M	U	M	S	U	U	S	U	S	
Phenol (5%)	U	S	U	-	S	M	M	-	S	U	M	U	U	S	U	M	S	M	S	U	U	S	U	M	M	M	S	
Phenol (50%)	U	S	U	-	S	U	M	-	S	U	M	U	U	U	U	U	S	U	M	U	U	S	U	U	U	M	S	
Phosphoric Acid (10%)	U	U	M	S	S	S	U	S	S	S	S	U	-	S	S	S	S	S	S	S	S	S	U	M	U	S	S	
Phosphoric Acid (conc.)	U	U	M	M	-	-	U	S	-	M	S	U	U	M	M	S	S	S	M	S	M	S	U	M	U	-	S	
Physiologic Media (Serum, Urine)	M	S	S	S	-	-	S	-	S	S	S	S	S	S	S	S	S	S	S	S	S	S	S	S	S	S	S	S
Picric Acid	S	S	U	-	S	M	S	S	S	M	S	U	S	S	S	U	S	S	S	S	U	S	U	M	S	M	S	
Pyridine (50%)	U	S	U	U	S	U	U	-	U	S	S	U	U	M	U	U	-	U	S	M	U	S	S	U	U	U	U	
Rubidium Bromide	M	S	S	-	S	S	S	-	S	S	S	S	S	S	S	-	-	S	S	S	S	S	S	M	S	S	S	

<b>CHEMICAL</b>	<b>MATERIAL</b>	ALUMINUM	ANODIC COATING for ALUMINUM	BUNA N	CELLULOSE ACETATE BUTYRATE	POLYURETHANE ROTOR PAINT	COMPOSITE Carbon Fiber/Epoxy	DELRIN	ETHYLENE PROPYLENE	GLASS	NEOPRENE	NORYL	NYLON	PET <sup>1</sup> , POLYCLEAR, CLEARCRIMP	POLYALLOMER	POLYCARBONATE	POLYESTER, GLASS THERMOSET	POLYETHERIMIDE	POLYETHYLENE	POLYPROPYLENE	POLYSULFONE	POLYVINYL CHLORIDE	RULON A, TEFLON	SILICONE RUBBER	STAINLESS STEEL	TITANIUM	TYGON	VITON
Rubidium Chloride	M	S	S	-	S	S	S	-	S	S	S	S	S	S	S	-	-	S	S	S	S	S	S	S	M	S	S	S
Sucrose	M	S	S	-	S	S	S	S	S	S	S	S	S	S	S	S	S	S	S	S	S	S	S	S	S	S	S	S
Sucrose, Alkaline	M	S	S	-	S	S	S	-	S	S	S	S	S	S	U	S	S	S	S	S	S	S	S	S	M	S	S	S
Sulfosalicylic Acid	U	U	S	S	S	S	S	-	S	S	S	U	S	S	S	-	S	S	S	-	S	S	S	U	S	S	S	
Nitric Acid (10%)	U	S	U	S	S	U	U	-	S	U	S	U	-	S	S	S	S	S	S	S	S	S	S	M	S	S	S	S
Nitric Acid (50%)	U	S	U	M	S	U	U	-	S	U	S	U	U	M	M	U	M	M	M	S	S	S	S	U	S	S	M	S
Nitric Acid (95%)	U	-	U	U	-	U	U	-	-	U	U	U	U	M	U	U	U	U	M	U	U	U	S	U	S	S	-	S
Hydrochloric Acid (10%)	U	U	M	S	S	S	U	-	S	S	S	U	U	S	U	S	S	S	S	S	S	S	S	S	U	M	S	S
Hydrochloric Acid (50%)	U	U	U	U	S	U	U	-	S	M	S	U	U	M	U	U	S	S	S	S	S	M	S	M	U	U	M	M
Sulfuric Acid (10%)	M	U	U	S	S	U	U	-	S	S	M	U	S	S	S	S	S	S	S	S	S	S	S	U	U	U	S	S
Sulfuric Acid (50%)	M	U	U	U	S	U	U	-	S	S	M	U	U	S	U	U	M	S	S	S	S	S	S	U	U	U	M	S
Sulfuric Acid (conc.)	M	U	U	U	-	U	U	M	-	-	M	U	U	S	U	U	U	M	S	U	M	S	U	U	U	-	S	
Stearic Acid	S	-	S	-	-	-	S	M	S	S	S	S	-	S	S	S	S	S	S	S	S	S	S	M	M	S	S	S
Tetrahydrofuran	S	S	U	U	S	U	U	M	S	U	U	S	U	U	U	-	M	U	U	U	U	S	U	S	S	U	U	
Toluene	S	S	U	U	S	S	M	U	S	U	U	S	U	U	U	S	U	M	U	U	U	S	U	S	U	U	M	
Trichloroacetic Acid	U	U	U	-	S	S	U	M	S	U	S	U	U	S	M	-	M	S	S	U	U	S	U	U	U	M	U	
Trichloroethane	S	-	U	-	-	-	M	U	-	U	-	S	U	U	U	U	U	U	U	U	U	S	U	-	S	-	S	
Trichloroethylene	-	-	U	U	-	-	-	U	-	U	-	S	U	U	U	U	U	U	U	U	U	S	U	-	U	-	S	
Trisodium Phosphate	-	-	-	S	-	-	M	-	-	-	-	-	-	S	-	-	S	S	S	-	-	S	-	-	S	-	S	
Tris Buffer (neutral pH)	U	S	S	S	S	S	S	-	S	S	S	S	S	S	S	S	S	S	S	S	S	S	S	S	S	S	S	S
Triton X-100	S	S	S	-	S	S	S	-	S	S	S	S	S	S	S	S	S	S	S	S	S	S	S	S	S	S	S	S
Urea	S	-	U	S	S	S	S	-	-	-	-	S	S	S	M	S	S	S	S	-	S	S	S	M	S	-	S	
Hydrogen Peroxide (10%)	U	U	M	S	S	U	U	-	S	S	S	U	S	S	S	M	U	S	S	S	S	S	S	M	S	U	S	
Hydrogen Peroxide (3%)	S	M	S	S	S	-	S	-	S	S	S	S	S	S	S	S	M	S	S	S	S	S	S	S	S	S	S	
Xylene	S	S	U	S	S	S	M	U	S	U	U	U	U	U	U	M	U	M	U	U	U	S	U	M	S	U	S	
Zinc Chloride	U	U	S	S	S	S	U	S	S	S	S	S	S	S	S	S	S	S	S	S	S	S	S	U	S	S	S	
Zinc Sulfate	U	S	S	-	S	S	S	S	S	S	S	S	S	S	S	S	S	S	S	S	S	S	S	S	S	S	S	
Citric Acid (10%)	M	S	S	M	S	S	M	S	S	S	S	S	S	S	S	S	S	M	S	S	S	S	S	S	S	S	S	

<sup>1</sup>Polyethyleneterephthalate

## A Chemical Compatibility Chart

### Key

S Satisfactory

M Moderate attack, may be satisfactory for use in centrifuge depending on length of exposure, speed involved, etc. Suggest testing under actual conditions of use.

U Unsatisfactory, not recommended.

-- Performance unknown; suggest testing, using sample to avoid loss of valuable material.

Chemical resistance data is included only as a guide to product use. No organized chemical resistance data exists for materials under the stress of centrifugation. When in doubt we recommend pretesting sample lots.

# Autoclaving Protocol

Date	Comment	Operator	Signature
1			
2			
3			
4			
5			
6			
7			
8			
9			
10			
11			
12			
13			
14			
15			
16			
17			
18			
19			
20			



## Your distribution partner

### Europe

#### Austria

VWR International GmbH  
Graumanngasse 7  
1150 Wien  
Tel.: 01 97 002 0  
Fax: 01 97 002 600  
E-mail: info@at.vwr.com

#### Belgium

VWR International bvba  
Researchpark Haasrode 2020  
Geldenaaksebaan 464  
3001 Leuven  
Tel.: 016 385 011  
Fax: 016 385 385  
E-mail:  
customerservice@be.vwr.com

#### Denmark

VWR - Bie & Berntsen  
Transformervej 8  
2730 Herlev  
Tel.: 43 86 87 88  
Fax: 43 86 87 90  
E-mail: info@dk.vwr.com

#### Finland

VWR International Oy  
Valimotie 9  
00380 Helsinki  
Tel.: 09 80 45 51  
Fax: 09 80 45 52 00  
E-mail: info@fi.vwr.com

#### France

VWR International S.A.S.  
Le Périgares – Bâtiment B  
201, rue Carnot  
94126 Fontenay-sous-Bois  
cedex  
Tel.: 0 825 02 30 30 (0,15 EUR  
TTC/min)  
Fax: 0 825 02 30 35 (0,15 EUR  
TTC/min)  
E-mail: info@fr.vwr.com

#### Germany

VWR International GmbH  
Hilpertstrasse 20a  
D - 64295 Darmstadt  
Tel.: 0180 570 20 00\*  
Fax: 0180 570 22 22\*  
E-mail: info@de.vwr.com  
\*0,14 €/Min. aus d. dt. Festnetz,  
Mobilfunk max. 0,42 €/Min.

#### Hungary

VWR International Kft.  
Simon László u. 4.  
4034 Debrecen  
Tel.: (52) 521-130  
Fax: (52) 470-069  
E-mail: info@hu.vwr.com

#### Ireland / Northern Ireland

VWR International Ltd / VWR  
International (Northern Ireland)  
Ltd  
Orion Business Campus  
Northwest Business Park  
Ballycoolin  
Dublin 15  
Tel.: 01 88 22 222  
Fax: 01 88 22 333  
E-mail: sales@ie.vwr.com

#### Italy

VWR International s.r.l.  
Via Stephenson 94  
20157 Milano (MI)  
Tel.: 02 332 03 11  
Fax: 800 152 999  
E-mail: info@it.vwr.com

#### The Netherlands

VWR International B.V.  
Postbus 8198  
1005 AD Amsterdam  
Tel.: 020 4808 400  
Fax: 020 4808 480  
E-mail: info@nl.vwr.com

#### Norway

VWR International AS  
Haavard Martinsens vei 30  
0978 Oslo  
Tel.: 02290  
Fax: 815 00 940  
E-mail: info@no.vwr.com

#### Poland

Labart Sp. z o.o.  
A VWR International Company  
Limbowa 5  
80-175 Gdansk  
Tel.: 058 32 38 210  
Fax: 058 32 38 205  
E-mail: labart@labart.pl

#### Portugal

VWR International - Material de  
Laboratório, Lda  
Edifício Neopark  
Av. Tomás Ribeiro, 43- 3 D  
2790-221 Carnaxide  
Tel.: 21 3600 770  
Fax: 21 3600 798/9  
E-mail: info@pt.vwr.com

#### Spain

VWR International Eurolab S.L.  
C/ Tecnología 5-17  
A-7 Llinars Park  
08450 - Llinars del Vallès  
Barcelona  
Tel.: 902 222 897  
Fax: 902 430 657  
E-mail: info@es.vwr.com

#### Sweden

VWR International AB  
Fagerstagatan 18a  
163 94 Stockholm  
Tel.: 08 621 34 00  
Fax: 08 621 34 66  
E-mail: info@se.vwr.com

#### Switzerland

VWR International AG  
Lerzenstrasse 16/18  
8953 Dietikon  
Tel.: 044 745 13 13  
Fax: 044 745 13 10  
E-mail: info@ch.vwr.com

#### UK

VWR International Ltd  
Customer Service Centre  
Hunter Boulevard  
Magna Park  
Lutterworth  
Leicestershire  
LE17 4XN  
Tel.: 0800 22 33 44  
Fax: 01455 55 85 86  
E-mail: uksales@uk.vwr.com

### Asia Pacific

#### China

VWR International China Co.,  
Ltd  
Suite 3B02, Qilai Building, No.  
889  
Yishan Road  
Shanghai 200233, China  
Tel.: +86- 21 521 388 22  
Fax: +86- 21 521 33 933  
E-mail: sales\_china@vwr.com

#### India

VWR Lab Products Pte Ltd  
2nd Floor, Front Wing, 135/12,  
Brigade Towers  
Brigade Road  
Bangaluru 560025 India  
Tel.: +91-2522-647911/922  
(Mumbai)  
Tel.: +91-80-41117125/26  
(Bangalore)  
Fax: +91-80-41117120  
E-mail: vwr\_india@vwr.com

#### Singapore

VWR Singapore Pte Ltd  
18 Gul Drive  
Singapore 629468  
Tel.: +65 6505 0760  
Fax: +65 6264 3780  
E-mail: sales@sg.vwr.com

**Go to [vwr.com](http://vwr.com) for the latest news, special offers and details of your local VWR distribution partner.**